

Instrument Case - ABS (1598 Series)

Plastic

Molded in P.C. card standoffs and vertical card guides...

Positive fit, tongue & groove construction requires only two mounting screws...

Brass bushings for repetitive assembly and disassembly...



Complete with four rubber feet and hardware...

For extra strength, front & back panels are made of aluminum...

OTHER KEY FEATURES

- Desk top electronic instrument enclosure, ideally suited for mounting printed circuit boards.
- Molded in flame retardant ABS plastic (material carries a UL flammability rating of 94V-0).
- Designed to meet IP54.
- Two sets of vertical 1.5 mm (0.062") P.C. board guides are molded into case halves front and rear.
- Front and rear panels are 1.6 mm (0.064") brushed aluminum with protective paper on one side.
- Cases halves are secured with M3 x 0.5" x 10 mm (0.39") Philips machine screws threaded into tapped integral brass bushings.
- Integral horizontal P.C. card mounts on Eurocard centers.
- Stocked in matte textured black and grey.
- EMI/RFI shielded cases are stocked in black (see table).

ACCESSORIES



Replacement Screws

Machine screws, used in flame retardant ABS 1598 series (ie...with brass inserts). M3 - 0.5" x 10 mm
1591MS100 - Package of 100



Nylon Circuit Board Standoffs

Self adhesive pad allows placement anywhere in the enclosure.
1598ZPC25 - Package of 25
1598ZPC100 - Package of 100

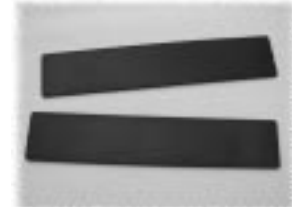

Optional Plastic End Panels (Black)

Molded from black fire retardant ABS plastic. Part contains both front & back panel.

- 1598PLABK** - Use with 1598A
- 1598PLBBK** - Use with 1598B
- 1598PLBBBK** - Use with 1598BB
- 1598PLCBK** - Use with 1598C
- 1598PLDBK** - Use with 1598D
- 1598PLEBK** - Use with 1598E
- 1598PLFBK** - Use with 1598F
- 1598PLGBK** - Use with 1598G
- 1598PLHBK** - Use with 1598H
- 1598PLJBK** - Use with 1598J



P.C. Board Screws

Self-tapping type, used in bosses in the 1598 series for P.C. board installation. #6 x 1/4" (6.4 mm)
1598ATS100 - Package of 100



Tilt Handles

Used as a tilt handle and/or bail - 8 detent positions.
1598TH1 - Use with 1598C,E,F & G
1598TH2 - Use with 1598D, H & J

Instrument Case - ABS (1598 Series)



Molded in Flame Retardant ABS

Plastic

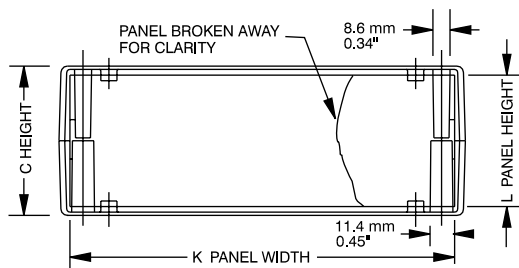
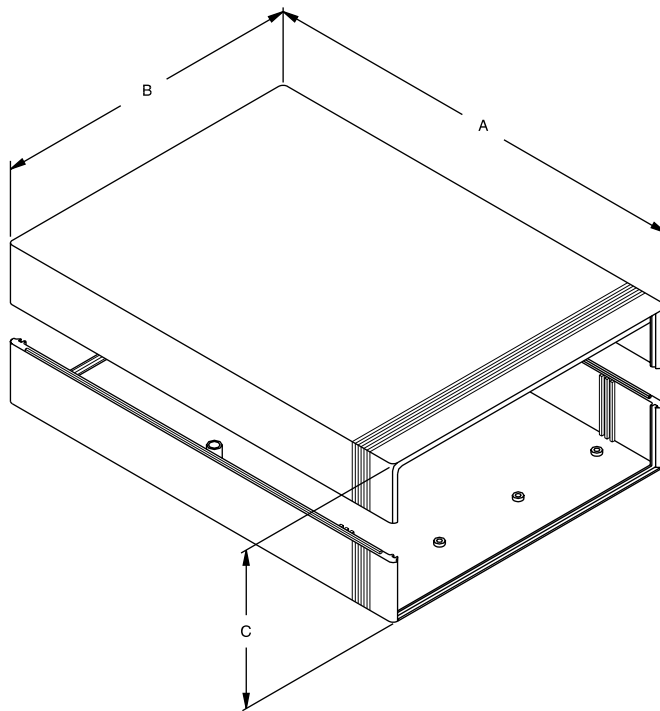

End View

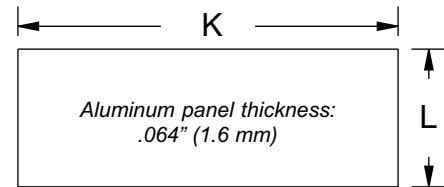

Front or Rear Panel

Part Number			Units	Dimensions			Panel Size	
Black	Grey	Black Shielded		A	B	C	K	L
1598BBK	1598BGY	1598RBBK	inch mm	5.28 134	5.31 135	1.96 50	5.04 128	1.77 45
1598ABK	1598AGY	1598RABK	inch mm	6.18 157	3.70 94	1.42 36	3.39 86	1.06 27
1598EBK	1598EGY	1598REBK	inch mm	6.30 160	6.30 160	3.38 86	5.98 152	3.11 79
1598BBBK	1598BBGY	1598RBBBK	inch mm	7.05 179	6.06 154	1.42 36	5.75 146	1.14 29
1598CBK	1598CGY	1598RCBK	inch mm	7.09 180	6.10 155	2.04 52	5.71 145	1.81 46
1598DBK	1598DGY	1598RDBK	inch mm	7.09 180	8.11 206	2.52 64	7.80 198	2.28 58
1598FBK	1598FGY	1598RFBK	inch mm	9.84 250	6.30 160	1.58 40	5.98 152	1.38 35
1598GBK	1598GGY	1598RGBK	inch mm	9.84 250	6.30 160	3.00 76	5.98 152	2.72 69
1598HBK	1598HGY	1598RHBK	inch mm	11.02 280	7.87 200	1.58 40	7.56 192	1.38 35
1598JBK	1598JGY	1598RJBK	inch mm	11.02 280	7.87 200	3.00 76	7.56 192	2.72 69

NOTES: - Average top & bottom wall thickness: 0.125" (3.2 mm)
- Average side wall thickness: 0.18" (4.5 mm)



CANADA
Guelph, Ontario (519) 822-2960
St. Laurent, Quebec (514) 343-9010
USA
Cheektowaga, NY (716) 651-0086



EUROPE
Basingstoke, UK +44 1256 812812

AUSTRALASIA
Queenstown, SA, Australia +61 8 8240 2244

1598 Series Drawings

Plastic

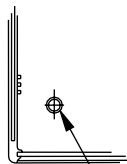
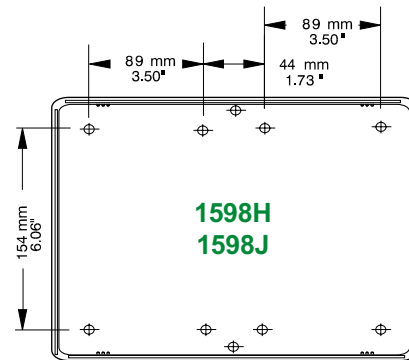
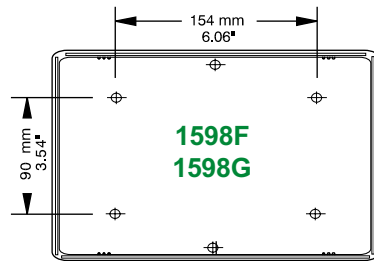
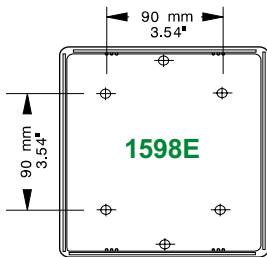
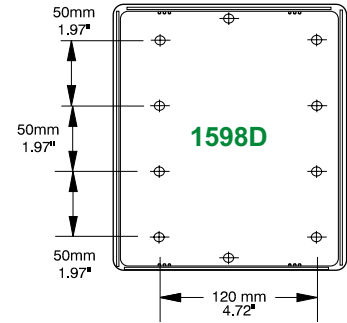
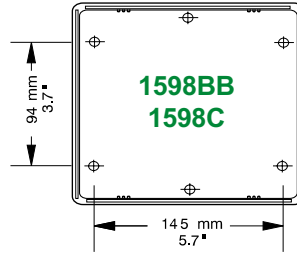
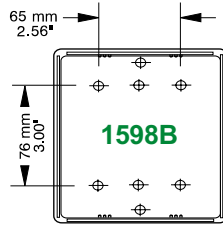
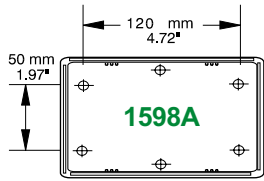

POST 3 mm I/S .12" I/S
8 mm DIA O/S .32" DIA O/S

P.C. Board Standoff Detail

For detailed drawings, CAD files and color photos visit our website at:
www.hammondmfg.com

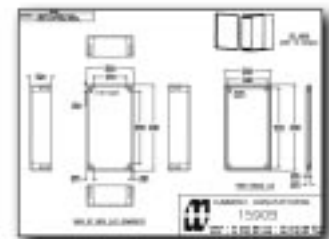
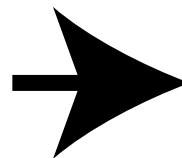

CANADA

Guelph, Ontario (519) 822-2960
St. Laurent, Quebec (514) 343-9010

USA

Cheektowaga, NY (716) 651-0086



EUROPE

Basingstoke, UK +44 1256 812812

AUSTRALASIA

Queenstown, SA, Australia +61 8 8240 2244